

pfmmedical

Quality and Experience · *since 1971*

 Made in Germany

**Titanised mesh implants
for reconstructive and
plastic-aesthetic breast
surgery**

› **TiLOOP® Bra Pocket**

› **TiLOOP® Bra**

www.pfmmedical.com



**Certified to
MDR (EU)**

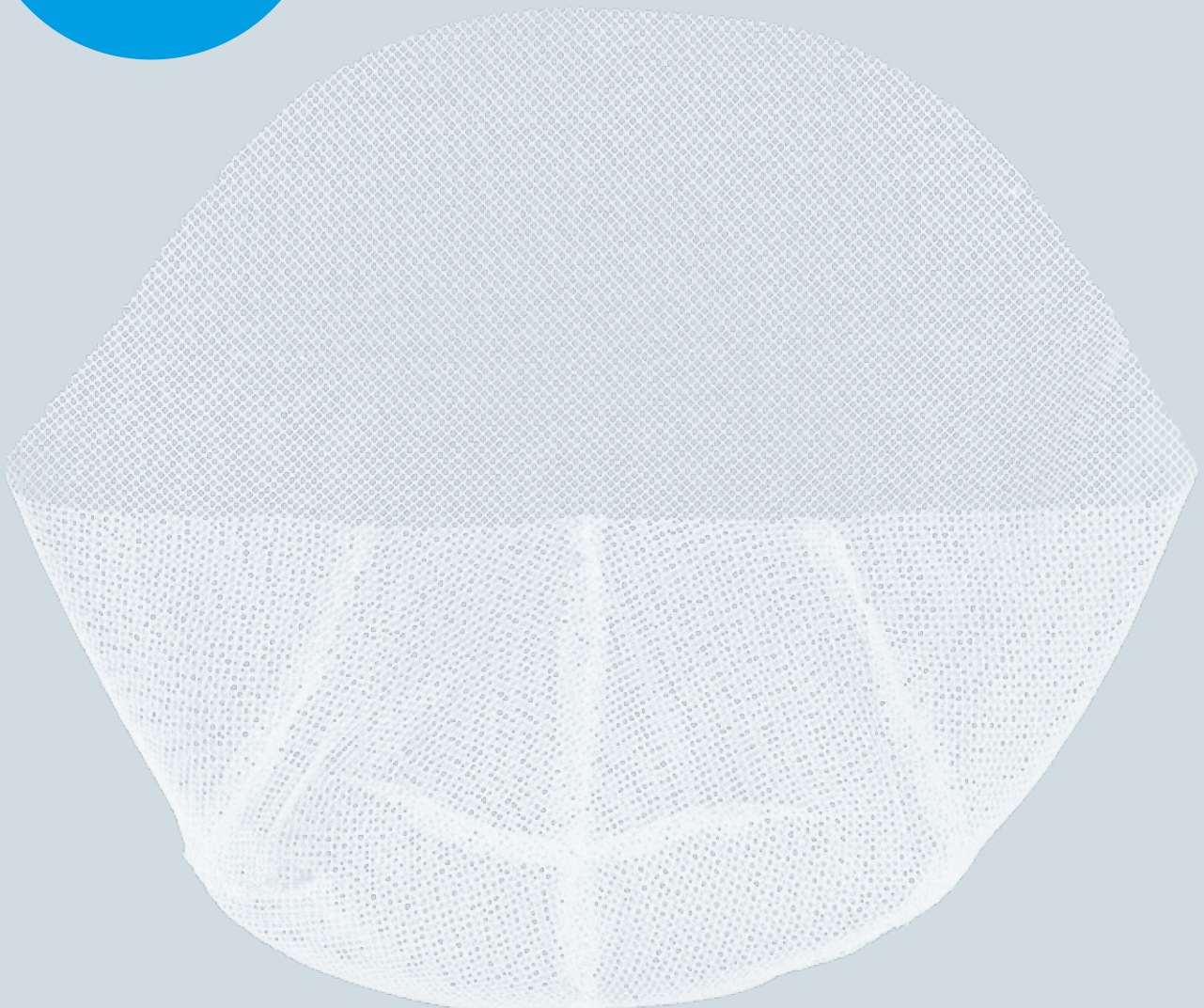

General benefits

Complete portfolio

The TiLOOP® Bra product range covers all indications for breast surgery with tissue-reinforcing material.

TiLOOP® Bra Pocket ▶ For pre-pectoral placement

TiLOOP® Bra ▶ For sub-pectoral/universal use

Extra light, extra soft

The TiLOOP® Bra extralight (16 g/m²) introduces the least amount of foreign material into the breast. The light weight material facilitates optimal tissue adaptation, which is of particular importance for the application in the sensitive breast area.

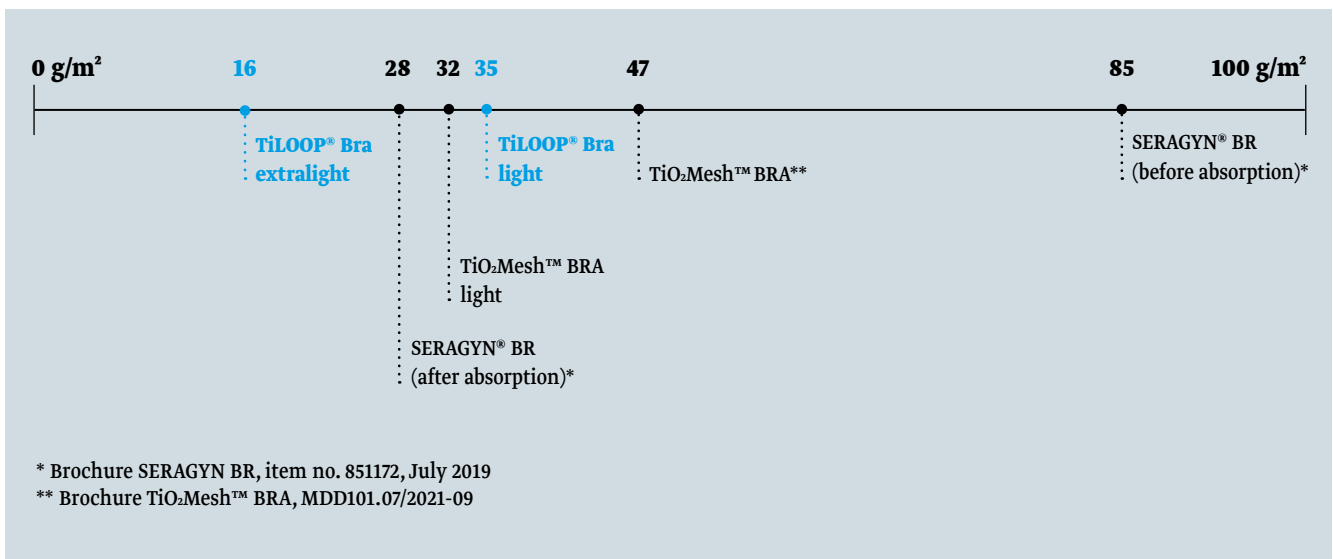

Surface weight comparison of synthetic meshes that are approved for breast surgery in Europe

Optimal capsule quality

Compared to simple polypropylene, the hydrophilic and titanised surface carries a reduced risk of inflammation¹ and thus a reduced tendency towards the formation of connective tissue-like scars and shrinkage: combined with minimal weight and large pores (1.0 mm), this provides the ideal conditions for a permanent, stable result as well as both desirable tissue ingrowth² and a vascularised, flexible, and therefore optimum capsule quality.

Quality proven in numerous studies

Our titanised meshes in breast surgery have been investigated in a large number of studies. TiLOOP® Bra has been used in breast surgery since 2008, and TiLOOP® Bra Pocket since 2017. A selection:

▶ **Reconstructions:** 250

Description: TiLOOP® Bra in implant-based immediate pre-pectoral reconstruction, prospective

Result: Higher quality of life, very high level of long-term patient satisfaction, very good aesthetic results and a low complication rate with TiLOOP® Bra

Author: Casella et al., 2018⁴

▶ **Reconstructions:** 22

Description: TiLOOP® Bra Pocket in implant-based immediate pre-pectoral reconstruction, prospective

Result: Simple and efficient use of the TiLOOP® Bra Pocket with a short implantation procedure, and consequently short exposure to sources of contamination

Author: Casella et al., 2019⁵

▶ **Reconstructions:** 216

Description: TiLOOP® Bra vs ADM in implant-based immediate reconstruction, prospective

Result: Lower complication rate, lower seroma rate and infection rate with TiLOOP® Bra

Author: Quah et al., 2019⁶

▶ **Reconstructions:** 362

Description: TiLOOP® Bra in implant-based sub-pectoral breast reconstruction, prospective

Result: High quality of life for patients with TiLOOP® Bra (12 months post-op)

Author: Thill et al., 2020³

▶ **Reconstructions:** 328

Description: Histological investigation into tissue integration of TiLOOP® Bra after pre-pectoral breast reconstruction

Result: The histological investigations show complete integration of TiLOOP® Bra into the tissue as well as physiological healing, a low complication rate, a low capsular contracture rate and high patient satisfaction

Author: Gentile et al., 2021²



You can find an overview of publications on our titanised meshes to download here.



You can find more information about our studies here:
www.pfmmedical.com/studies

General details

- ▶ Titanised type 1a polypropylene mesh
- ▶ Weight: 16 or 35 g/m²
- ▶ Pore size: 1.0 mm
- ▶ Monofilament fabric
- ▶ Non-absorbable
- ▶ Atraumatic, laser-cut edges
- ▶ EO-sterilised (ethylene oxide), pyrogen-free

Knowledge

The right decision for or against the use of a tissue-reinforcing material (synthetic mesh or acellular dermal matrix (ADM)) is decisive for the long-term quality of a successful breast operation.

TiLOOP® Bra mesh implants* are type 1a polypropylene meshes (macroporous, lightweight and monofilament) with a titanised, hydrophilic surface. This offers many advantages compared to simple polypropylene:

- ▶ Better cell growth⁷
- ▶ Lower risk of inflammation¹
- ▶ Less scar formation⁸
- ▶ Less mesh shrinkage¹

Titanisation of the mesh implants

Due to the biocompatibility of titanium this metal has been used in many medical fields ever since 1946.⁹ In 2022, pfmmmedical succeeded in developing a globally unique process in which titanium is transferred to a flexible and elastic base material, specifically polypropylene mesh. TiLOOP® Bra und TiLOOP® Bra Pocket mesh implants are type 1a polypropylene meshes (macroporous, lightweight and monofilament) with a hydrophilic surface created by titanisation. A hydrophilic mesh implant integrates better into the surrounding tissue than a hydrophobic mesh.

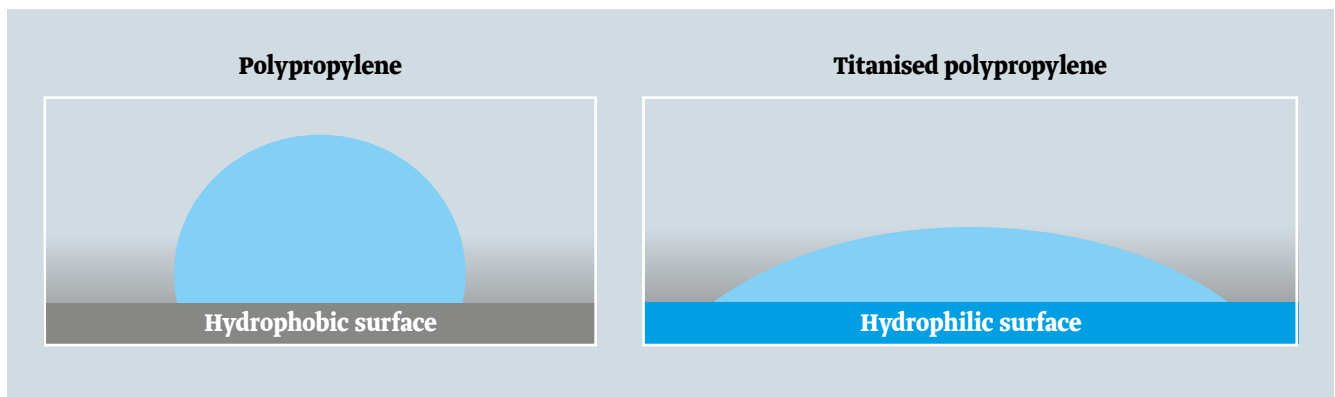

Behaviour of a water drop on a hydrophobic and a hydrophilic surface

Biocompatibility

The human body consists of approximately 70% water, so the titanised, and therefore hydrophilic, surface of our mesh implants gives better tolerance.^{1, 10}

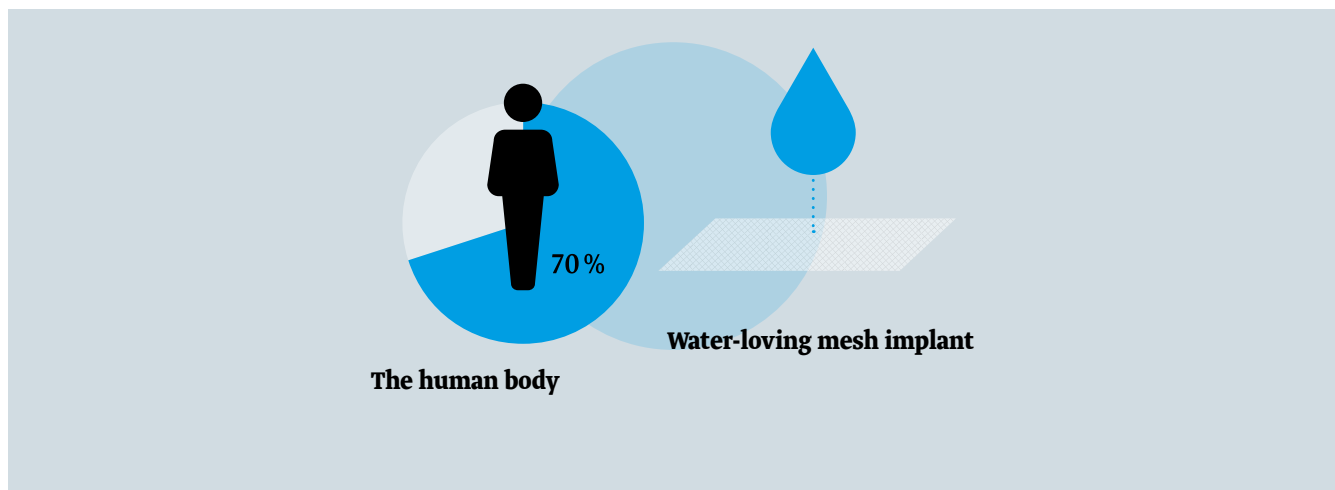

*TiLOOP® Bra mesh implants are not a tissue replacement.

Increased cell vitality through titanisation

Compared to a polypropylene surface, fibroblasts on a titanised surface are more vital and grow better.⁷

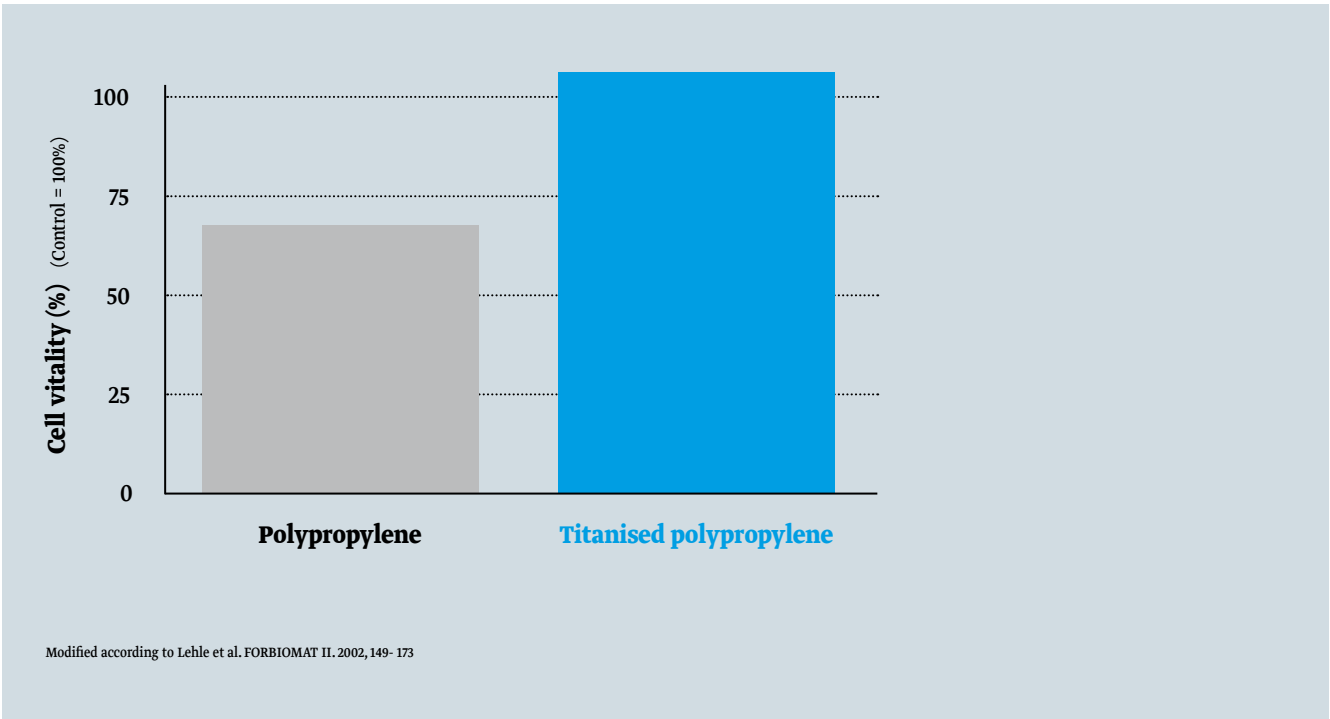

Increase in cell vitality of fibroblasts with titanisation of a polypropylene surface



You can find more information about our titanisation here.

TiLOOP® Bra Pocket

View



Benefits

Muscle-preserving pre-pectoral

Pre-pectoral placement of the implant has the advantage that the muscle does not have to be detached from the chest wall, which in turn means less postoperative pain. The result is a rapid recovery after surgery and preservation of muscle function. Your patients can resume their daily lives sooner.

Excellent aesthetic results

Pre-pectoral placement enables the breast implant to assume the physiological position of the subcutaneous breast tissue. This means excellent aesthetics and a natural ptosis are achieved.^{11, 12, 13}

Excellent quality of life

The pre-pectoral reconstruction and the associated benefits improve the patients' quality of life.^{4, 12, 13}

Shorter surgery

TiLOOP® Bra Pocket is a ready-to-use implant. No lengthy fitting procedure, e.g., via intraoperative sutures or hydration, is required. The pre-pectoral reconstruction takes less time than the sub-pectoral reconstruction, since there is no need to prepare the pectoralis major.⁵ The patient is therefore anaesthetised for a shorter period.

Protected implant

TiLOOP® Bra Pocket is an implant pocket that fixes the freely selectable breast implant on the muscle and can thereby prevent dislocation or twisting. Studies have provided evidence of a low capsule contracture rate, while maintaining an excellent capsule quality.^{8, 11}

Stretch-optimised implant

The stretch properties of TiLOOP® Bra Pocket have been developed to meet the physiological demands of natural shoulder movements and ptosis.

Free choice of implant

TiLOOP® Bra Pocket can be used regardless of the implant shape and surface.

Range of application

TiLOOP® Bra Pocket can be used in any breast surgery where the pre-pectoral placement of tissue-supporting, reinforcing and bridging materials is indicated.

- ▶ **Reconstructive breast surgery:** implant-based reconstruction (also with expander), e.g. skin-sparing or nipple-sparing mastectomy
- ▶ **Plastic-aesthetic breast surgery:** primary or corrective augmentations

Application

Recommended implantation procedure

TiLOOP® Bra Pocket is fixed on the fascia of the pectoralis major muscle or directly on the muscle itself. The front surface of the implant facing the skin is completely covered with mesh material. TiLOOP® Bra Pocket is fixed pre-pectorally at the cranial, medial and lateral side so as to prevent dislocation of the mesh and implant.

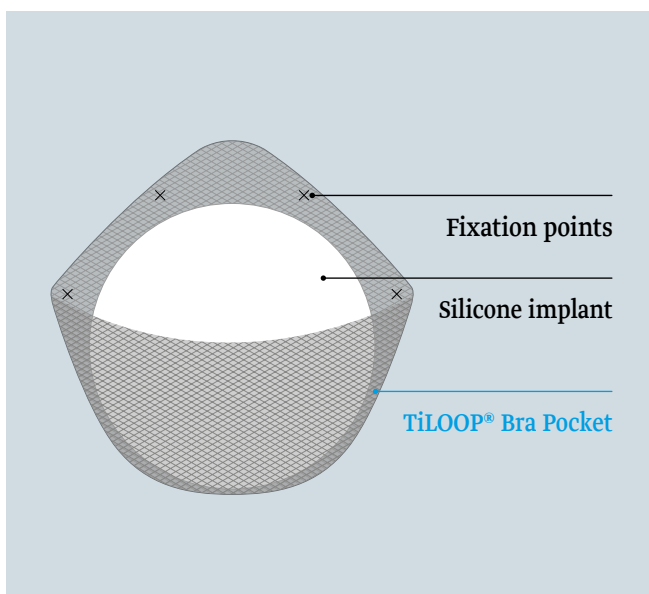

Recommended fixation points
View of the back of the mesh (which is touching the thoracic wall)

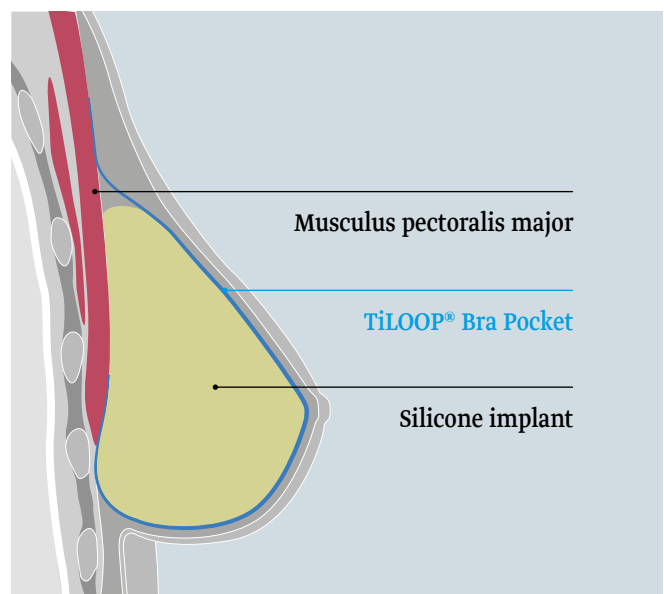

Pre-pectoral position of the TiLOOP® Bra Pocket

Order information

TiLOOP® Bra Pocket ▶ Guide for selecting the mesh size

Size	Implant width	Implant projection height	Implant Volume	Weight	Surface	REF	PU
small	< 11.0 cm	< 4.5 cm	< 270 ml	16 g/m ²	425.66 cm ²	6001383	1
medium	< 13.0 cm	< 5.5 cm	< 420 ml	16 g/m ²	539.23 cm ²	6001385	1
large	< 15.0 cm	< 6.0 cm	< 550 ml	16 g/m ²	704.06 cm ²	6001387	1

TiLOOP® Bra

View

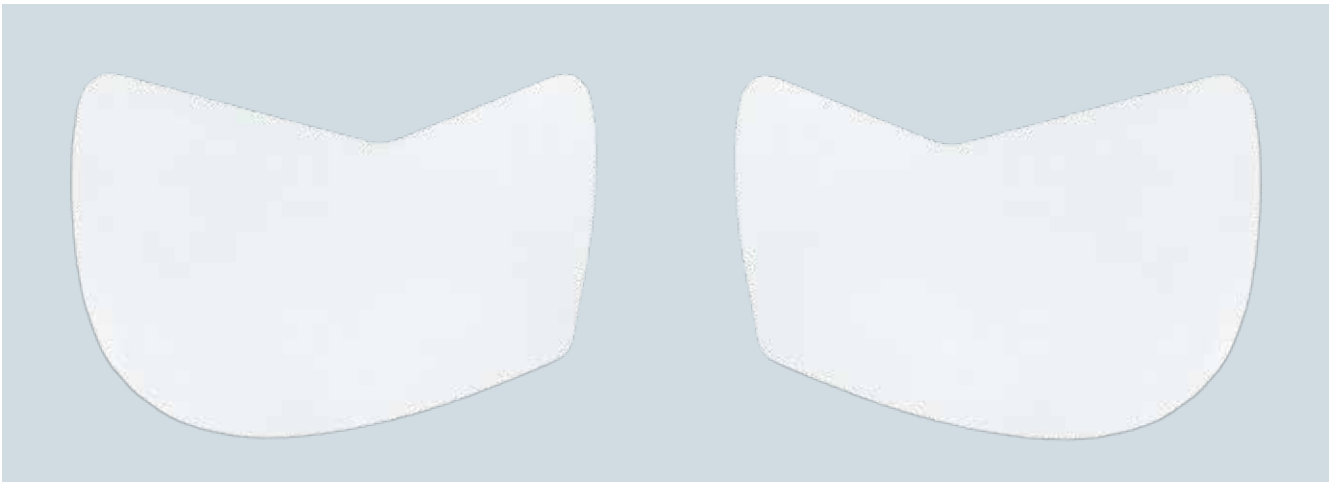

Range of application

TiLOOP® Bra serves to support, strengthen and bridge the body's own tissue structures, as part of reconstructive and plastic-aesthetic breast surgery.

- ▶ Primary breast reconstruction, e.g. after skin-sparing or nipple-sparing mastectomy
- ▶ Secondary breast reconstruction
- ▶ Replacement of breast implant

Versatile

TiLOOP® Bra can be used for primary or secondary breast reconstruction. The use of an expander is also possible.

Application

TiLOOP® Bra is intended for extension of the pectoralis major, in case of sub-pectoral, implant-based (permanent implant or expander) breast reconstruction. TiLOOP® Bra covers and fixes the caudal pole of the breast implant. The pectoralis major is protected from cranial movement.

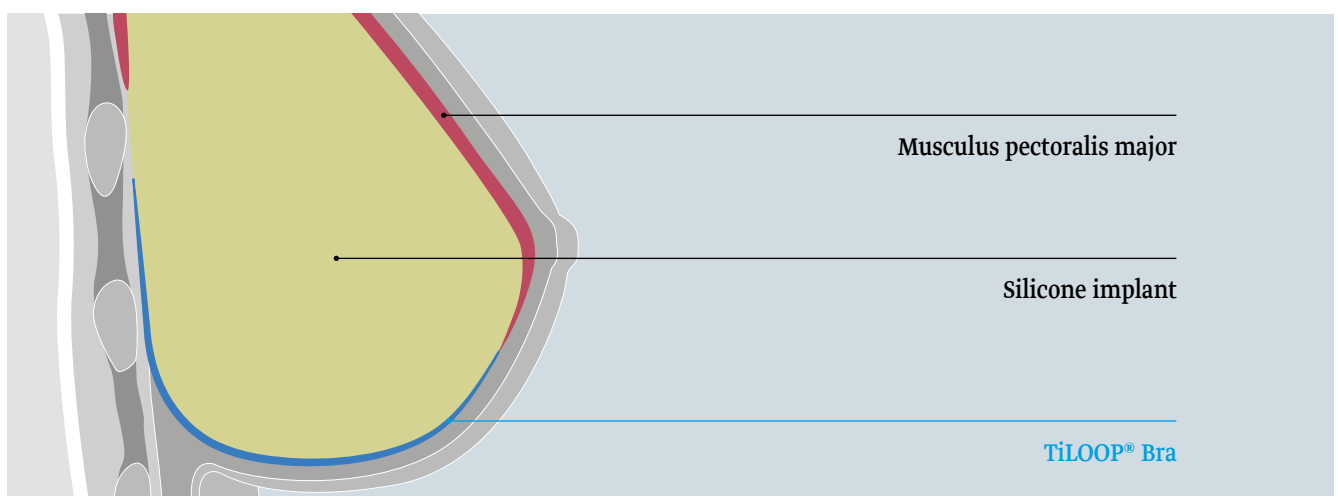

Sub-pectoral position of TiLOOP® Bra

Dimensions

TiLOOP® Bra

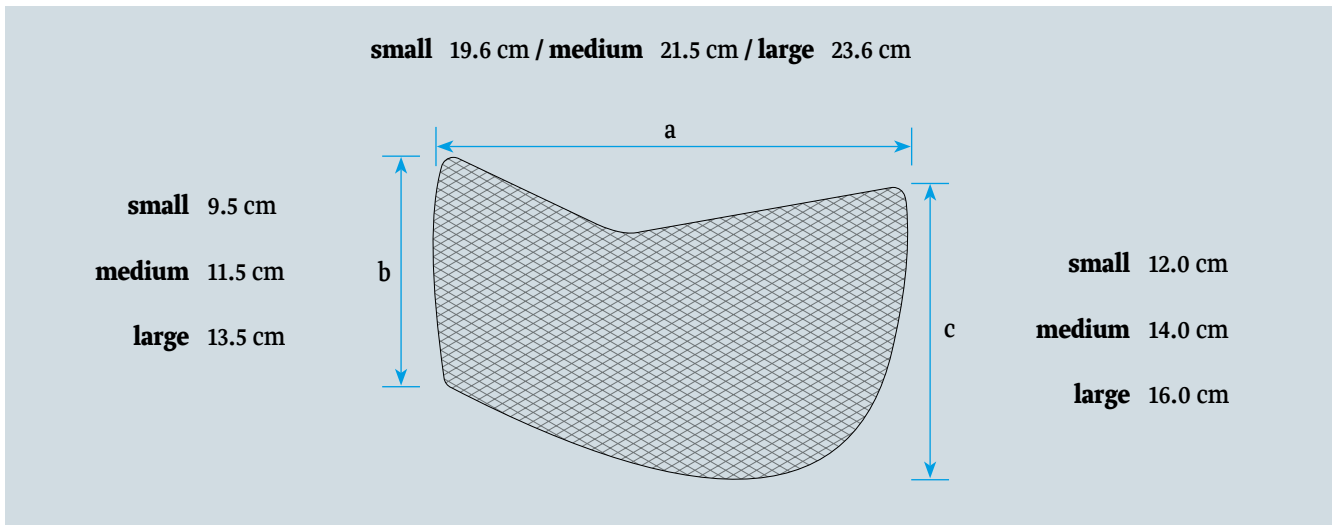

Order information

TiLOOP® Bra

Size	Weight	Surface	REF	PU
small	16 g/m ²	252.06 cm ²	6000636	1
	35 g/m ²	252.06 cm ²	6000639	1
medium	16 g/m ²	333.50 cm ²	6000637	1
	35 g/m ²	333.50 cm ²	6000640	1
large	16 g/m ²	449.84 cm ²	6000638	1
	35 g/m ²	449.84 cm ²	6000641	1

A series of horizontal dotted lines for writing notes.

1. Scheidbach et al., In vivo studies comparing the biocompatibility of various polypropylene meshes and their handling properties during endoscopic total extraperitoneal (TEP) patchplasty: an experimental study in pigs. *Surg Endosc*, 2004, 18(2): 211-220
2. Gentile et al., Titanium-coated polypropylene mesh as innovative bioactive material in conservatives mastectomies and pre-pectoral breast reconstruction. *Bioact Mater*, 2021, 6(12): 4640-4653
3. Thill et al., Patient reported outcome and cosmetic evaluation following implant based breast-reconstruction with a titanized polypropylene mesh (TiLOOP® Bra): A prospective clinical study in 269 patients. *Eur J Surg Oncol*, 2020, 46(8): 1484-1490
4. Casella et al., Nipple-sparing bilateral prophylactic mastectomy and immediate reconstruction with TiLoop® Bra mesh in BRCA1/2 mutation carriers: A prospective study of long-term and patient reported outcomes using BREAST-Q. *Breast*, 2018, 39: 8-13
5. Casella et al., Evaluation of pre-pectoral implant placement and complete coverage with TiLoop Bra Mesh for breast reconstruction: a prospective study on long term and patient reported BREAST-Q outcomes. *Plast Reconstr Surg*, 2019, 143(1): 1e-9e
6. Quah et al., Veritas in Immediate Implant-based Breast Reconstruction Is Associated with Higher Complications Compared with TiLOOP. *Plastic and Reconstructive Surgery - Global Open*, 2019, 7(12): e2533
7. Lehle et al., Verbesserung des Langzeitverhaltens von Implantaten und anderen Biomaterialien auf Kunststoffbasis durch plasmaaktivierte Gasphasenabscheidung (PACVD). Abschlussbericht Forschungsverbund "Biomaterialien (FORBIOMAT II)", 2002, 149-173
8. Scheidbach et al., Influence of Titanium Coating on the Biocompatibility of a Heavyweight Polypropylene Mesh. *Eur Surg Res*, 2004, 36: 313-317
9. Wintermantel et al., *Medizintechnik Life Science Engineering*. Berlin Heidelberg: Springer-Verlag, 2009, ed. 5
10. Horstmann et al., Impact of polypropylene amount on functional outcome and quality of life after inguinal hernia repair by the TAPP procedure using pure, mixed, and titanium-coated meshes. *World J Surg*, 2006, 30(9): 1742-1749
11. Casella et al., TiLOOP® Bra mesh used for immediate breast reconstruction: comparison of retropectoral and subcutaneous implant placement in a prospective single-institution series. *Eur J Plast Surg*, 2014, 37(11): 599-604
12. Bernini et al., Subcutaneous Direct-to-Implant Breast Reconstruction: Surgical, Functional, and Aesthetic Results after Long-Term Follow-Up. *Plast Reconstr Surg Glob Open*, 2016, 3(12): e574
13. Casella et al., Subcutaneous Tissue Expander Placement with Synthetic Titanium-Coated Mesh in Breast Reconstruction: Long-term Results. *Plast Reconstr Surg Glob Open*, 2016, 3(12): e577

Links





Workshops
www.pfmmedical.com/meshworkshops



Videos
www.pfmmedical.com/meshvideos

Contact

Should you have any questions our Customer Solutions Team will be glad to advise you.

 service@pfmmedical.com
 +49 (0)2236 9641-220
 +49 (0)2236 9641-51

pfm medical ag
Wankelstraße 60
50996 Köln
Germany

Certified according to
DIN EN ISO 13485

Follow us!



Manufacturer

pfm medical titanium GmbH, Südwestpark 42, 90449 Nuremberg, Germany

CE 0124

